

**DAVEY**

# **Maverick™**

## **Wheeled Suction Pool Cleaner**

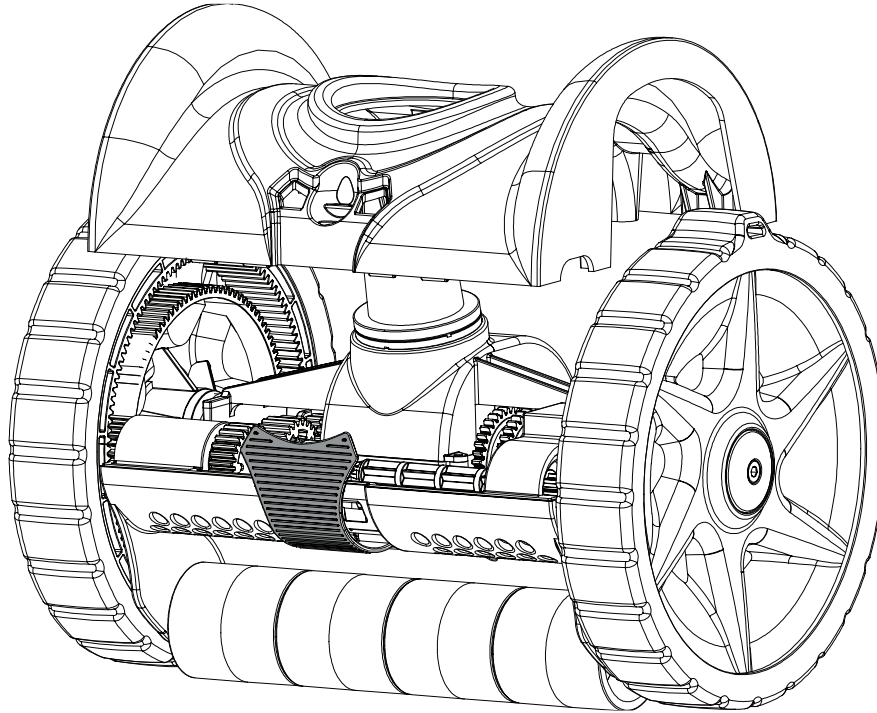

## **Owner's Manual**

for the Installation and Service of the

---

## **Maverick Tune Up Kit**

---

### **Replacement Wearable Parts**



Should the installer or owner be unfamiliar with the correct installation or operation of this type of equipment you should contact the distributor/manufacture for the correct advice before proceeding with the installation or operation of this product. The pump operator or owner must be provided with this owner's manual.

## Tools Required

The only tool required is a 5mm Allen Key or Screwdriver with a 5mm Hex Bit.

## Instructions

1. Undo the cover clip.
2. Detach the top cover to expose the cleaner internals.

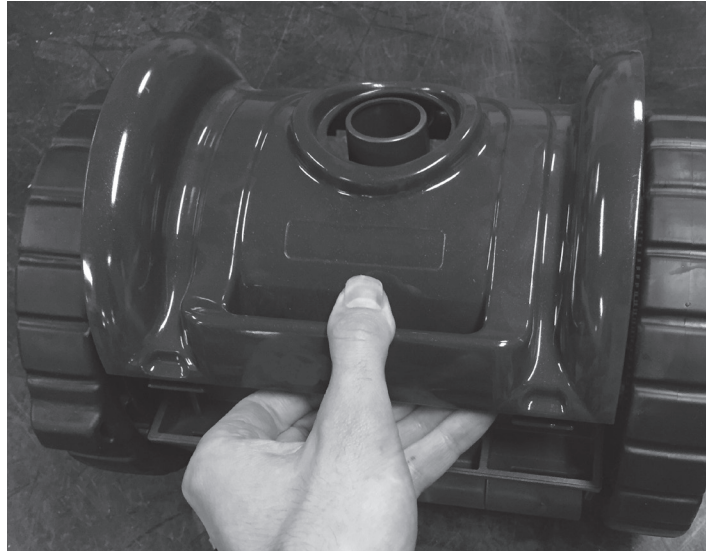
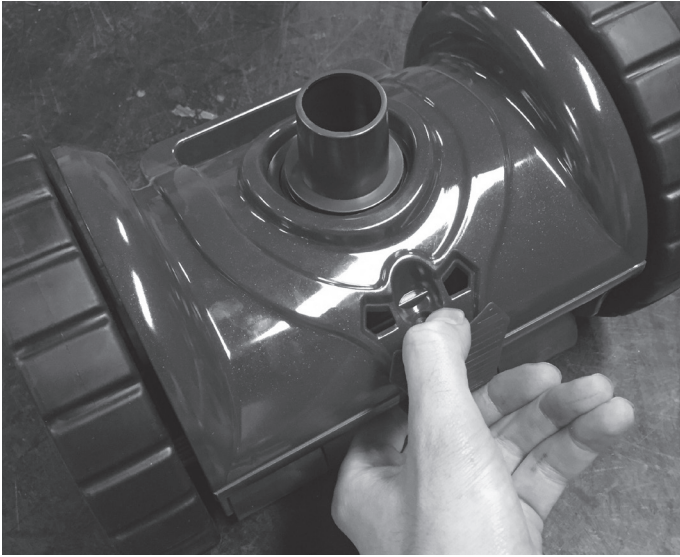

3. Remove the turbine cover.

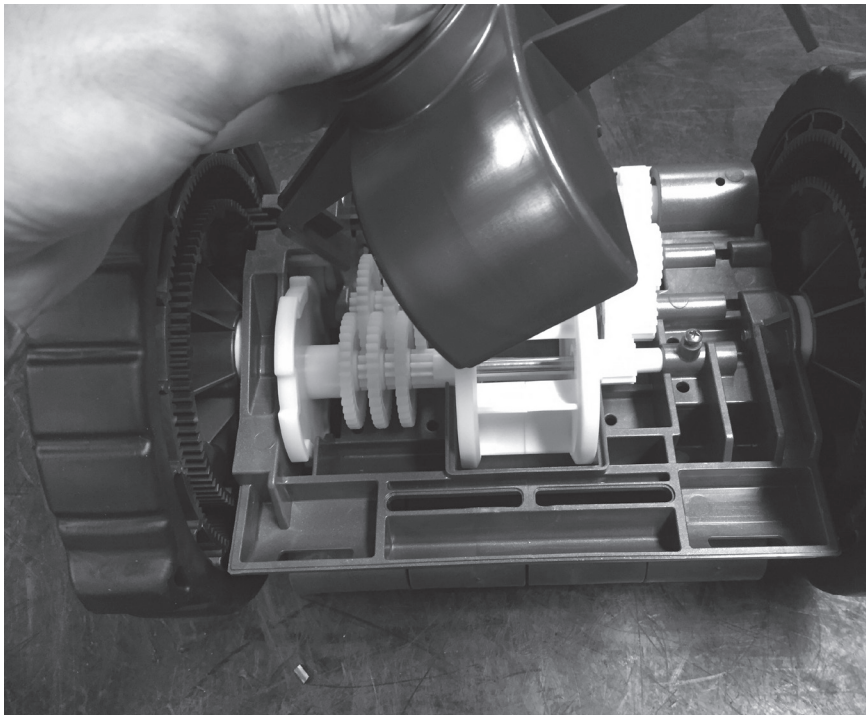

4. Insert allen-key into wheel screw and turn anti-clockwise. Remove both wheels.

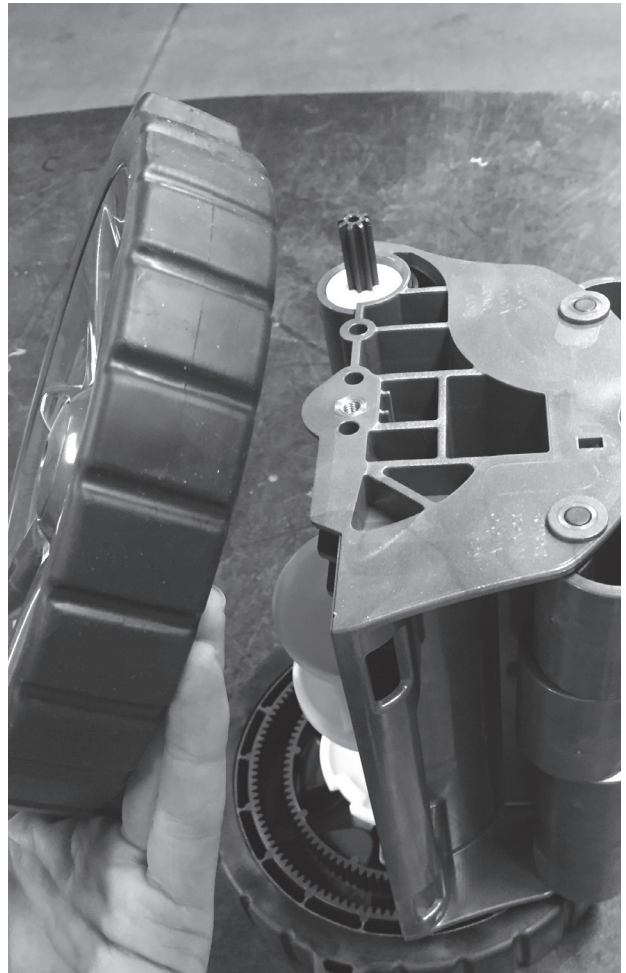

5. Remove reversing drive assembly and drive shaft.

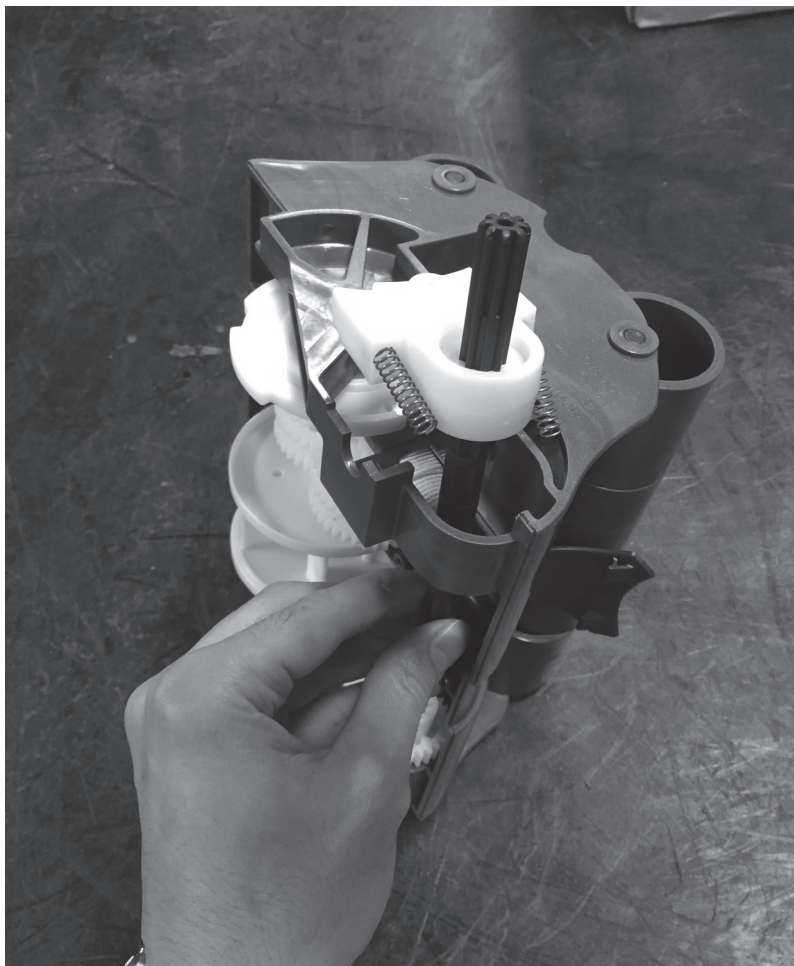

6. Remove forward drive gear.

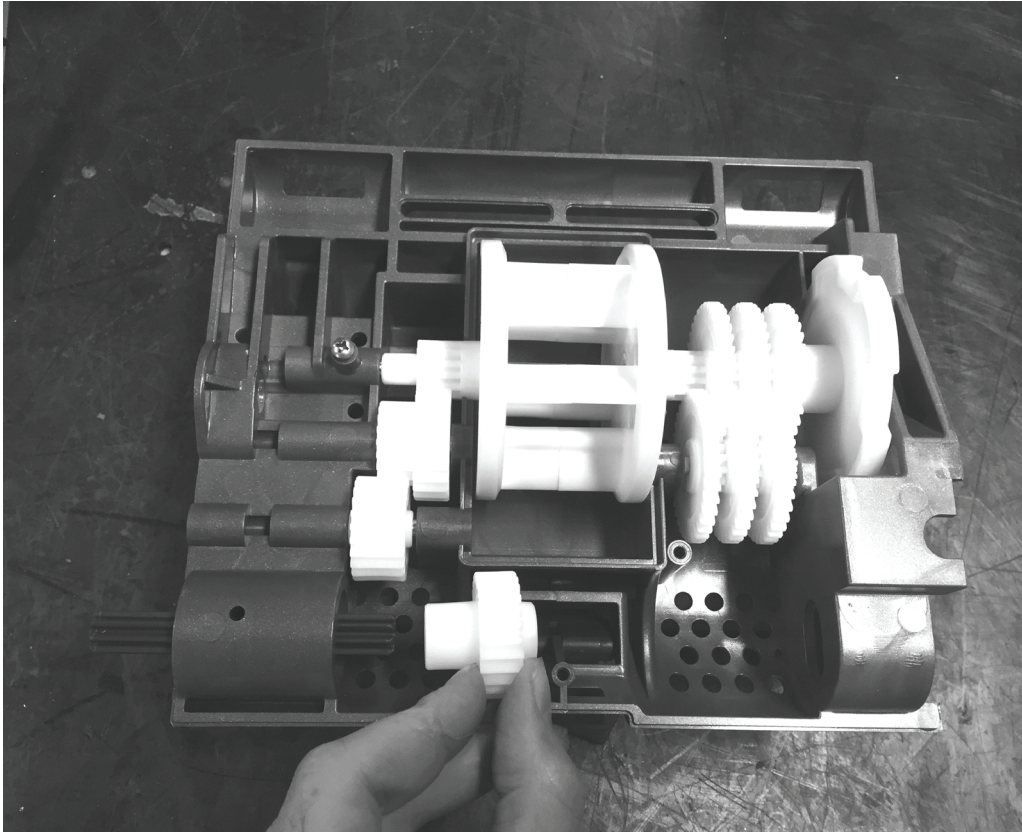

7. Remove forward drive shaft and one of two bearings. 8. Remove second bearing.

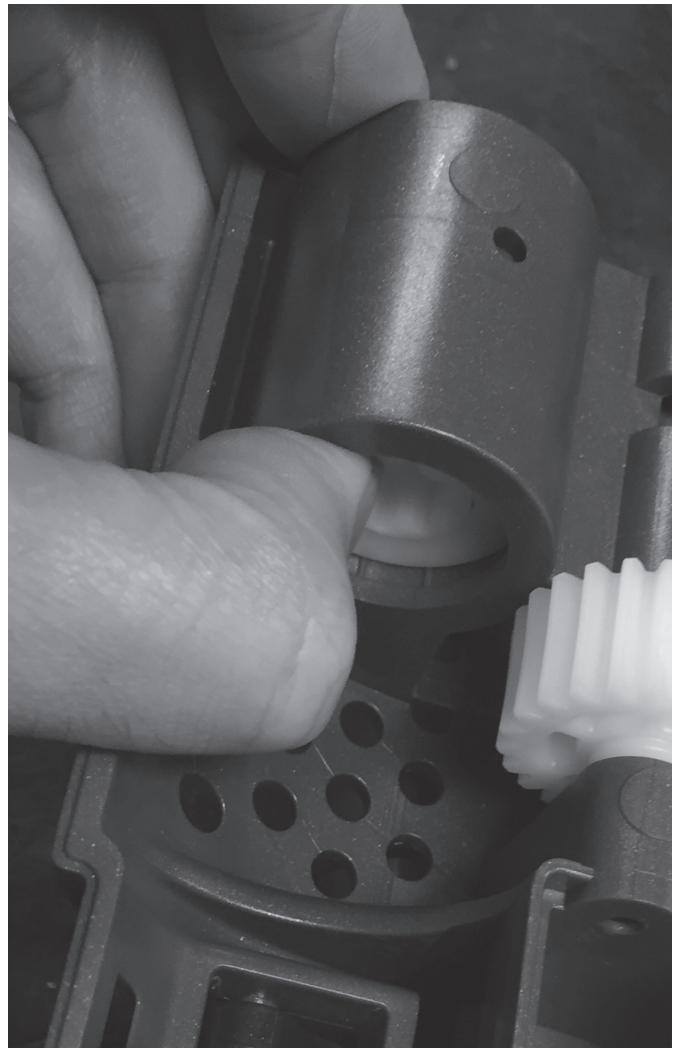
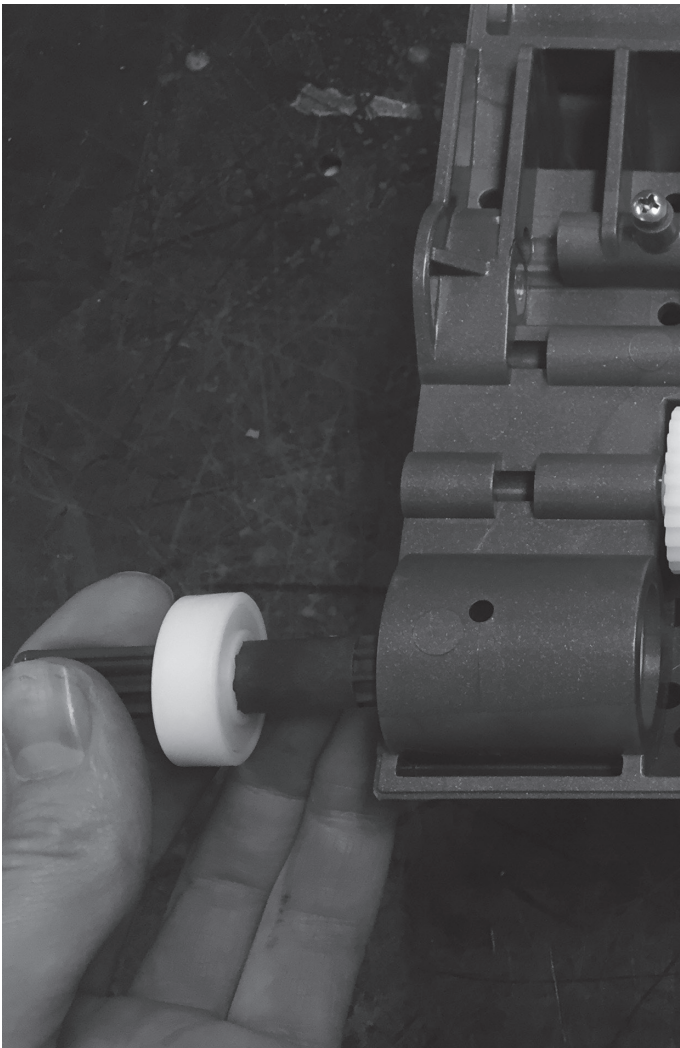

9. Assemble forward drive kit, like so:

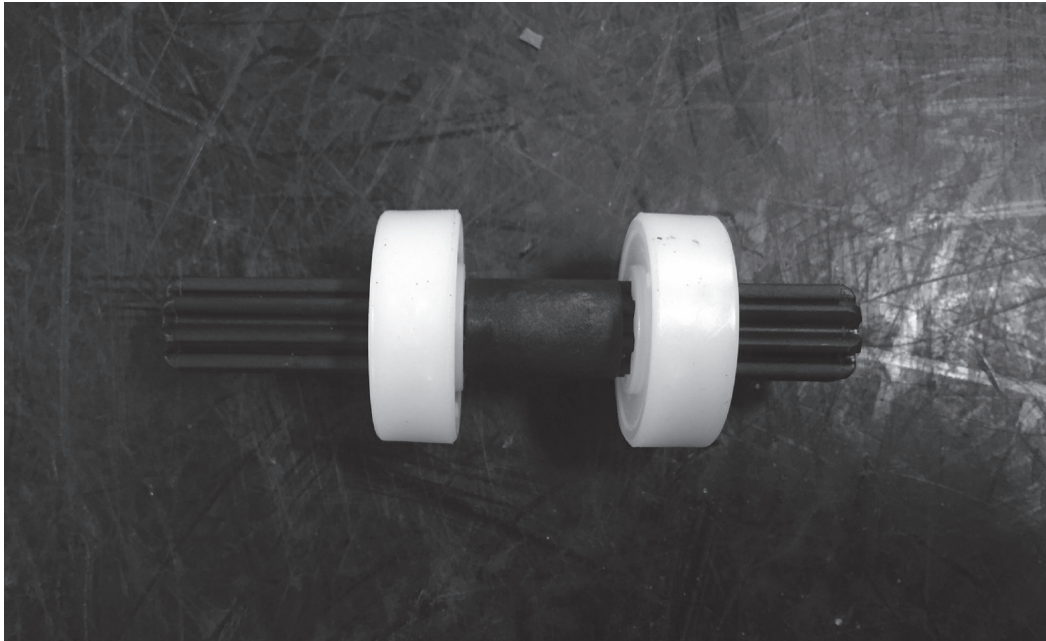

10. Insert forward drive kit.

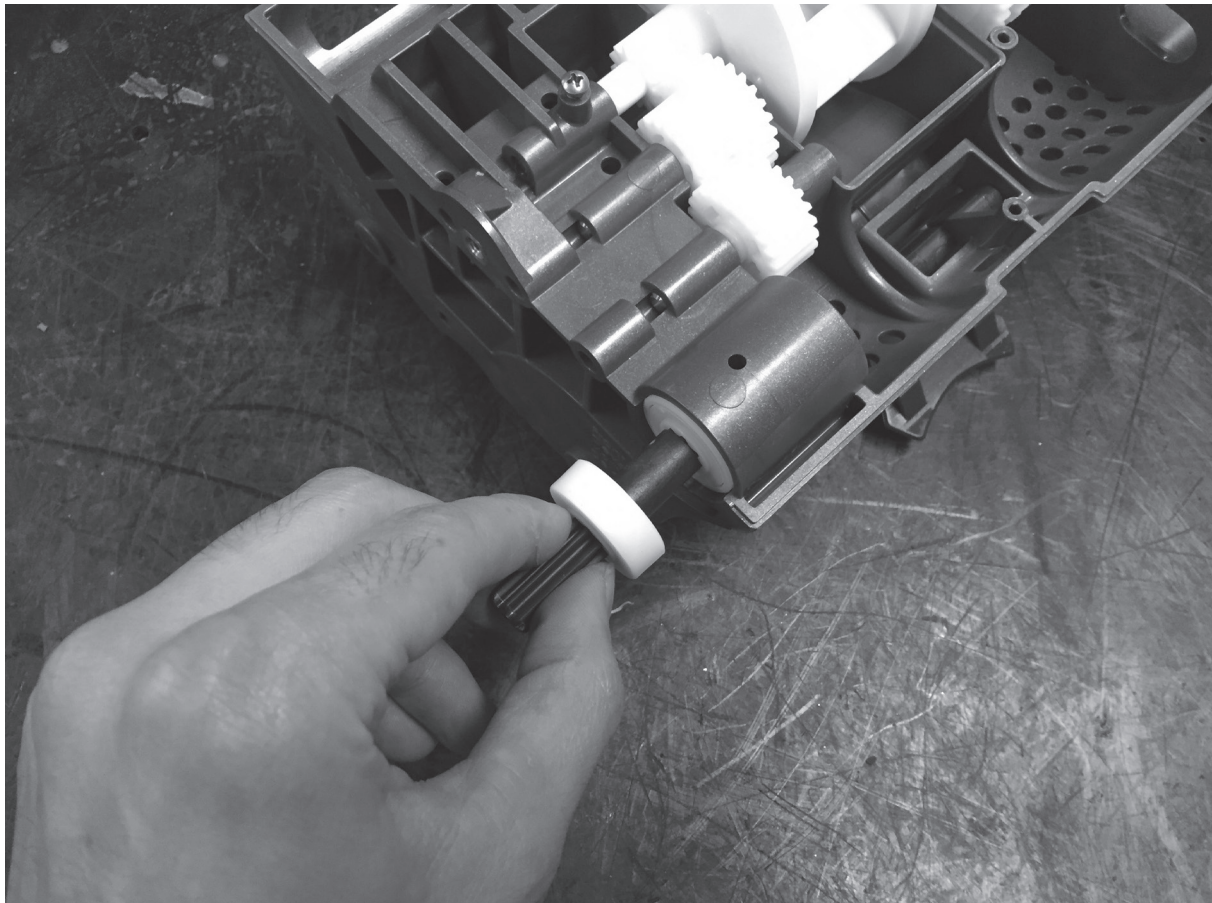

11. Insert forward drive gear.

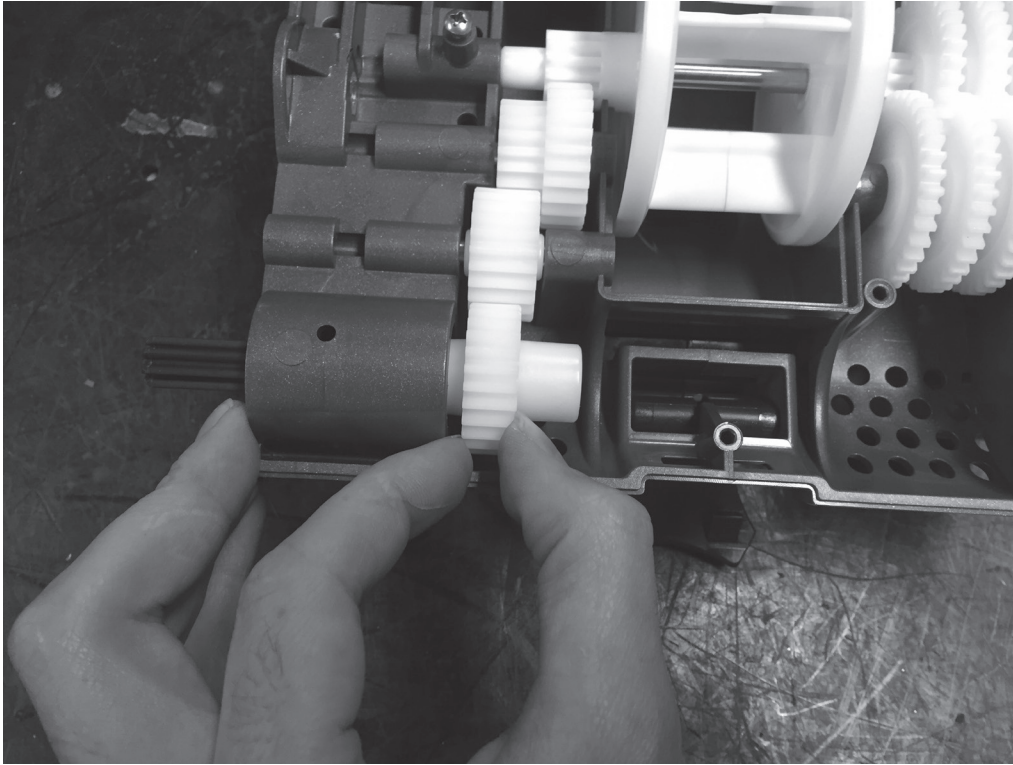

12. Insert reversing drive assembly and drive shaft.

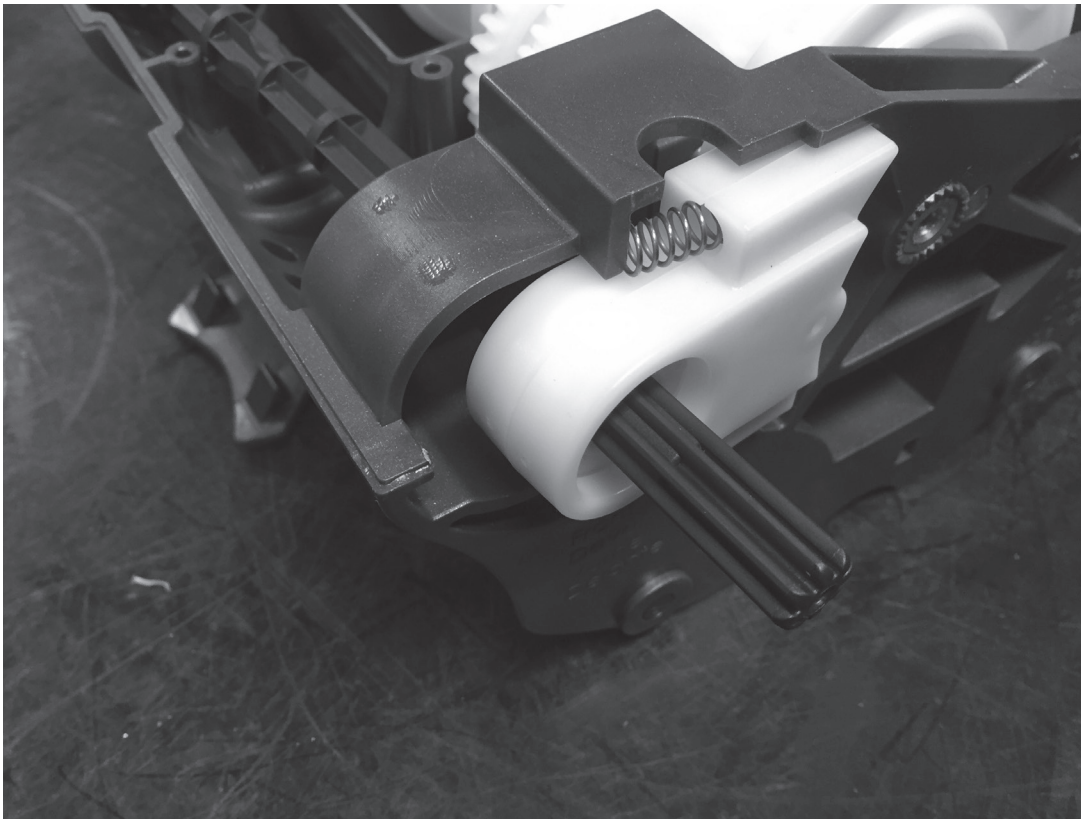

13. Push reversing drive assembly in, so that wheel engages with cam.

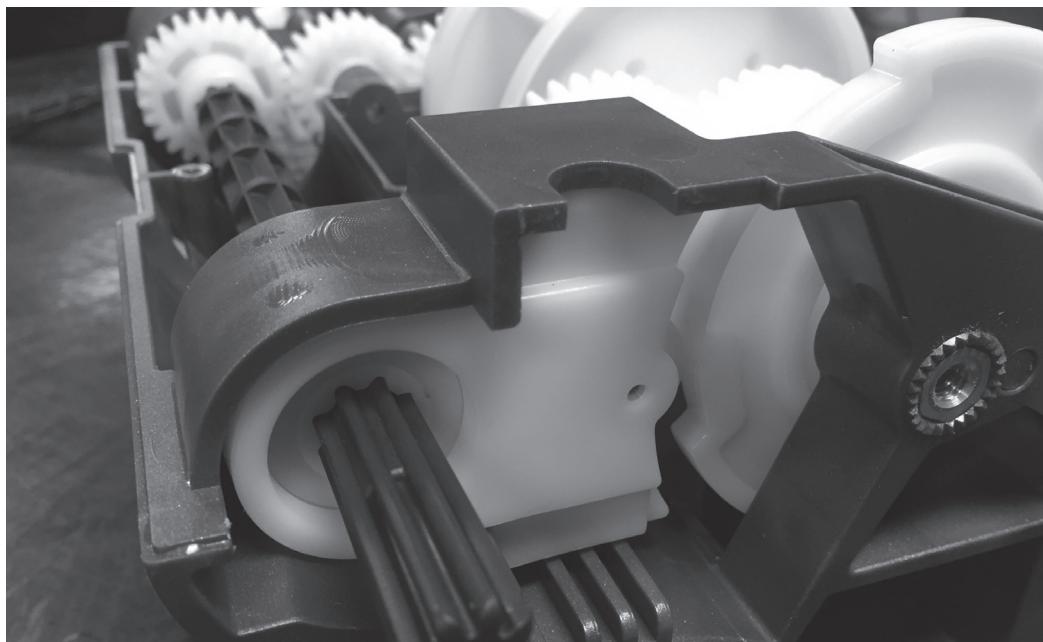

14. Install turbine cover.

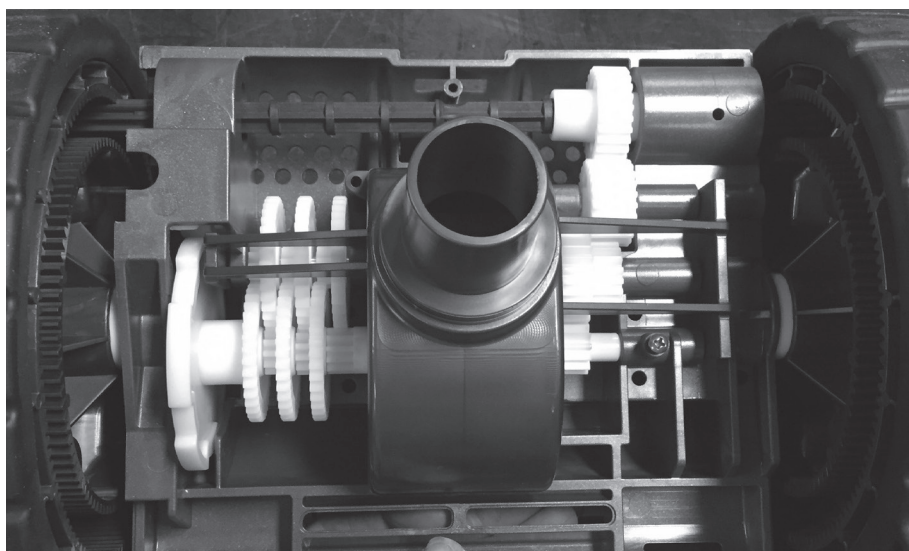

15. Replace cover and clip on.





**Davey Water Products Pty Ltd**  
Member of the GUD Group  
ABN 18 066 327 517

#### **AUSTRALIA**

##### **Head Office**

6 Lakeview Drive,  
Scoresby, Australia 3179  
Ph: +613 9730 9124  
Fax: +613 9753 4248  
Email: [export@davey.com.au](mailto:export@davey.com.au)  
Website: [davey.com.au](http://davey.com.au)

#### **NEW ZEALAND**

7 Rockridge Avenue,  
Penrose, Auckland 1061  
Ph: 0800 654 333  
Fax: 0800 654 334  
Email: [sales@dpw.co.nz](mailto:sales@dpw.co.nz)  
Website: [daveynz.co.nz](http://daveynz.co.nz)

#### **NORTH AMERICA**

Ph: 1-877-885-0585  
Email: [info@daveyusa.com](mailto:info@daveyusa.com)  
Website: [daveyusa.com](http://daveyusa.com)

#### **EUROPE**

ZAC des Gaulnes  
355 Avenue Henri Schneider  
69330 Meyzieu, France  
Ph: +33 (0) 4 72 13 95 07  
Fax: +33 (0) 4 72 33 64 57  
Email: [info@daveyeurope.eu](mailto:info@daveyeurope.eu)  
Website: [daveyeurope.eu](http://daveyeurope.eu)

#### **MIDDLE EAST**

Ph: +971 50 6368764  
Fax: +971 6 5730472  
Email: [info@daveyuae.com](mailto:info@daveyuae.com)  
Website: [daveyuae.com](http://daveyuae.com)

© Davey is a trademark of Davey Water Products Pty Ltd. © Davey Water Products Pty Ltd 2019.

DWP1755

\* Installation and operating instructions are included with the product when purchased new. They may also be found on our website.